

emotron®



EL-FI® M20

SHAFT POWER MONITOR INSTRUCTION MANUAL

Motor shaft output power measurement



TABLE OF CONTENTS

- 1 Inside the box...
- 2 Safety
- 3 Wiring
- 4 Selection current transformer
- 5 Operation
- 6 Programming
 - 6.1 Set Measurement Unit "HP" or "kW"
 - 6.2 Set RATED MOTOR POWER and CURRENT (Windows 41, 42)
 - 6.3 Set NUMBER OF PHASES (Window 43)
 - 6.4 Monitor Function (Window 05)
 - 6.5 Set the START DELAY (Window 31)
 - 6.6 Set Alarm levels with AUTOSET
 - 6.7 Set the RESPONSE DELAY (Window 32)
- 7 Advanced features
- 8 Troubleshooting
- 9 Technical data
- 10 Parameter list
- 11 Service

1 INSIDE THE BOX ...

This instruction manual describes the installation and commissioning of the M20 load monitor. The M20 supervises induction motor driven equipment and provides alarms when abnormal conditions are detected. The M20's ability to provide reliable monitoring & protection ensures production equipment is optimised and expensive breakdowns and interruptions are minimized. Due to the special method of subtracting motor power losses, the monitor is able to accurately measure the shaft power supplied by the motor to the application. This advanced technique allows the M20 to monitor the “application” load only as opposed to the “total” motor load, which includes the varying motor losses.

- Check the delivery. Your shipment should contain the M20 load monitor, a current transformer and this instruction manual.
- Check carefully that the ordered equipment complies with the motors input voltage and that the current transformer rating is as stated on the delivery packaging.
- Check that the contents have not been damaged in shipping.

Note!

If in doubt contact your supplier before starting to install or commissioning the product.

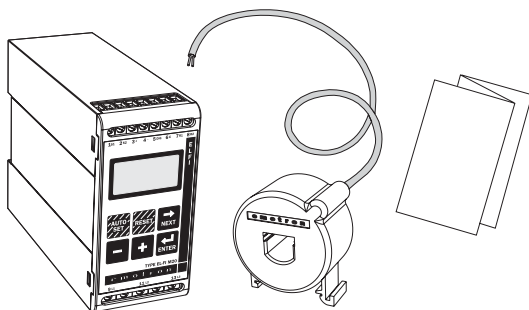

2 SAFETY

- Study this manual thoroughly before installing and using the monitor.
- The monitor must be installed by qualified personal.
- Always disconnect supply circuits prior to installing.
- The installation must comply with standard and local regulations.
- Pay special attention to this SAFETY section and the part marked “CAUTION!” in the OPERATION section.
- Should questions or uncertainties arise, please contact your local sales outlet or see section 11 SERVICE.

Note!

Do not remove or break the seal on the housing. The warranty will be cancelled.

3 WIRING

This wiring example shows how the M20 can be used to control the starting and stopping circuit of the motor. Other wiring configurations are possible.

1. The current transformer CTMxxx must be placed in the same phase that is connected to terminal 9, phase L1.
2. For single-phase connection see fig 2.

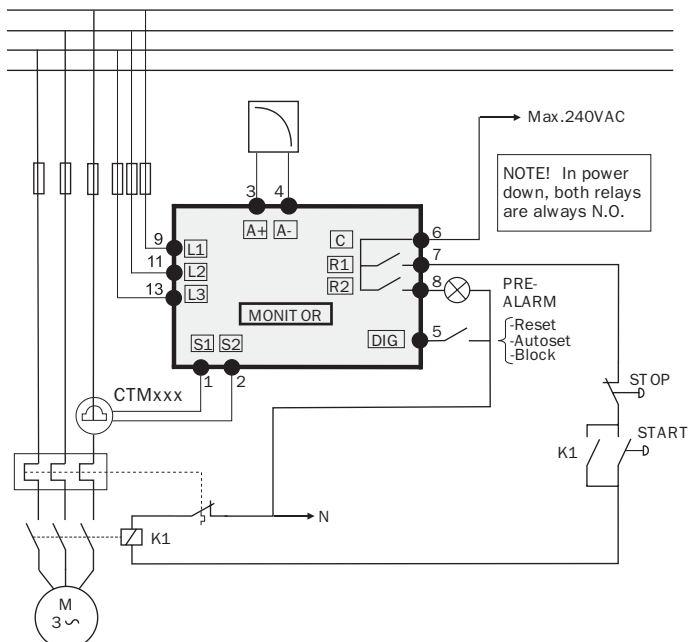

Fig 1. Connection example

Note!

If the START/STOP is connected according to fig. 1, it is recommended that terminals 6 and 7 be by-passed during programming. After the programming is completed the by-pass must be taken out.

ALTERNATIVE EXAMPLE FOR SINGLE-PHASE CONNECTION

This wiring example shows the deviant power connection to be made with regard to a single-phase connection. Refer to fig. 1 for the remaining wiring.

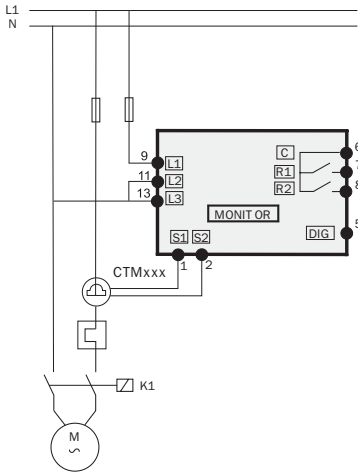

Fig 2. Single-phase connection example.

EXAMPLE - DIGITAL INPUT

The Digital Input use the terminals 5 (DIG) and 6 (C-reference). It can have either a VAC or a VDC signal. Connect “+” to terminal 5 (DIG) and “-” to terminal 6 for VDC signal. See also section 7 ADVANCED FEATURES.

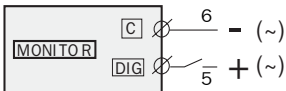

Fig 3. Wiring example for digital input.

4 SELECTION CURRENT TRANSFORMER

FOR MOTORS LESS THAN 100A

1. Check the rated motor current on the motor plate.
2. Compare this value with the current in table 1.
3. From table 1, select the current transformer and the appropriate numbers of windings.

Note!

Max length of the CTM cable is 1 m (39.37 in).

EXAMPLE:

- Rated motor current = 12A.
- Select 10.1-12.5A from the first colon in table 1.
- This gives:
 - CTM025 with 2 windings.

RATED MOTOR CURRENT [A]	CURRENT TRANSFORMER TYPE NUMBER OF WINDINGS			
	CTM 010	CTM 025	CTM 050	CTM 100
0.4 – 1.0	10			
1.01 – 2.0	5			
2.01 – 3.0	3			
3.1 – 5.0	2			
5.1 – 10.0	1			
10.1 – 12.5		2		
12.6 – 25.0		1		
26.0 – 50.0			1	
51.0 – 100.0				1

Table 1. CT less than 100A.

Note!

Normally the appropriate Current Transformer (CT) will have been ordered and shipped with the M20, check that this is the case; contact the supplier if in doubt.

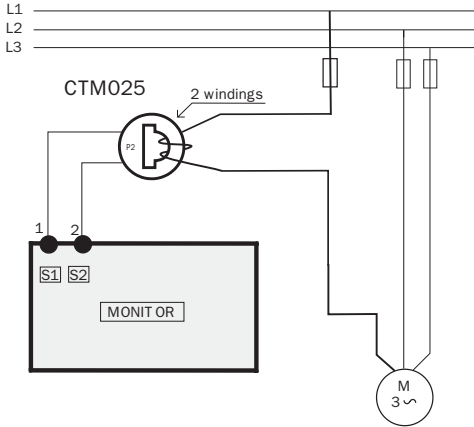

Fig 4. Example CTM 025 with 2 windings for an 12 A motor.

Note!

The transformer connection and orientation are not polarity sensitive, but must be connected to L1.

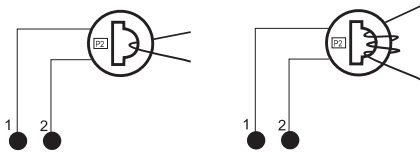

Fig 5. Example 1 and 3 windings.

FOR MOTORS GREATER THAN 100A

1. Check the rated motor current on the motor plate.
2. Compare this value with the current in table 2.
3. Select from table 2 the primary and the secondary current transformer and the appropriate numbers of windings.

EXAMPLE :

- Rated motor current = 260A.
- Select 251-500A from the first colon in table 2.
- This gives:
 - Primary transformer 500:5, 1 winding.
 - CTM010 with 2 windings.

RATED MOTOR CURRENT [A]	CURRENT TRANSFORMER TYPE and NUMBER OF PRIMARY WINDINGS
101 – 150	150:5 + CTM 010 1 + 2
151 – 250	250:5 + CTM 010 1 + 2
251 – 500	500:5 + CTM 010 1 + 2
501 – 999	1000:5 + CTM 010 1 + 2

Table 2. CT greater than 100 A

Note!

Normally the appropriate Current Transformer (CT) will have been ordered and shipped with the M20, check that this is the case; contact the supplier if in doubt.

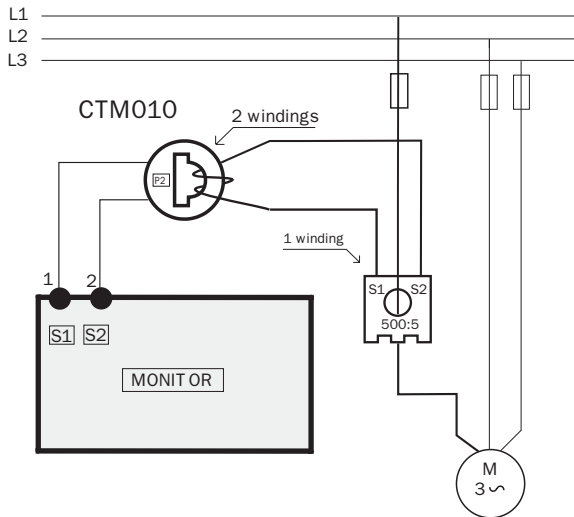

Fig 6. Example of a CTM 010 with 2 windings and a primary transformer 500:5 with 1 winding for a 260 A motor.

Note!

The transformer connection and orientation are not polarity sensitive, but must not be connected to L1.

5 OPERATION

Overview

Control terminals:

- 1 S1 Current transformer input
- 2 S2 Current transformer input
- 3 + Analog output
- 4 - Analog output
- 5 DIG External RESET or AUTO SET or Block Pre-Alarm
- 6 C Common: RELAY, DIG
- 7 R1 Main Alarm Relay 1
- 8 R2 Pre-Alarm Relay 2

LCD display:

- 12 Function (window) number
- 123 Function Value
- ⚠ Warning signal
- ⌚ Start-, response delay or block timer active
- 🔒 Parameter locked
- V Voltage indicator
- A Current indicator
- mA Milliamp indicator
- kW Kilowatt indicator
- S Second indicator
- % Per cent indicator

AUTO SET key:

Press for 3 seconds during normal and stable load to apply the automatic setting of the alarm levels. Not available if Parameter Locked.

NEXT key:

Proceeds to next window. If no key is pressed for 1 minute the display returns to window 01 automatically.

RESET key:

To reset ALARM

ENTER key:

Confirm (save) changes.

+/- keys:

Increasing and decreasing value

After Power up window 01 appears. It shows the actual load value.
Default view (example shows 54% load):

Motor terminals:

- 9 L1 Motor phase
- 11 L2 Motor phase
- 13 L3 Motor phase

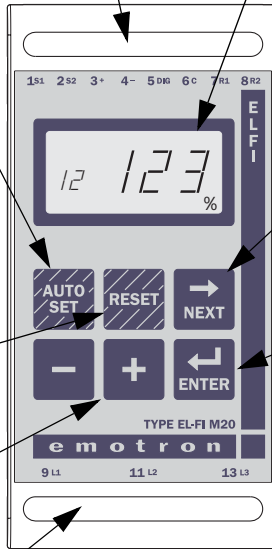

Use the NEXT key to scroll through the function menu.

WINDOW MENU

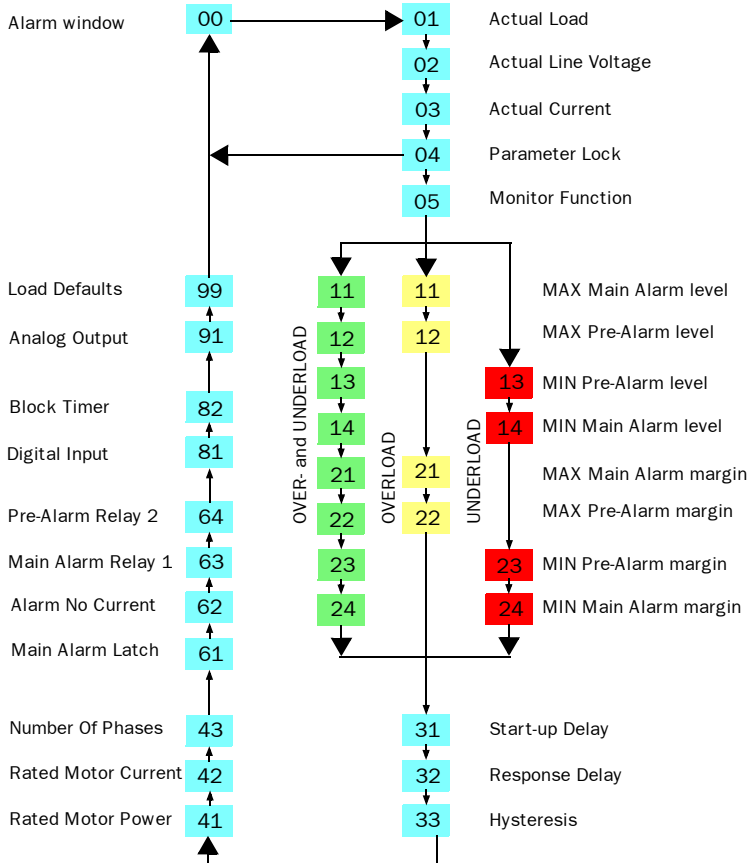

- The ALARM window 00 only appears if an Alarm output is active.
- The Actual Load window 01 Appears after power up.
- Use the  key to scroll through the menu.



- The Actual Load window will appear automatically if no keys are pressed for longer than 1 minute.
- If the PARAMETER LOCK is on, only windows **01** **02** **03** **04** are visible.
- Window **05** selects the monitor function, see section 6:4.

HOW TO CHANGE A VALUE

Example setting the RATED MOTOR CURRENT in window 42.

1. Press  until the window number 42 appears.





2. Press  or  until the desired value is reached (e.g. 23A).



3. Press  to confirm and save the change.

Note!

If the value is NOT to be changed, press the  before the  is pressed.

CAUTION!

Make sure that all safety measures have been taken before switching on the supply voltage and starting the motor/machine in order to avoid personal injury.

6 PROGRAMMING

6:1 Set Measurement Unit “HP” or “kW”



Selecting the unit of measurement

The unit of measurement can be set to kilowatts or Horsepower both as absolute or relative values. This setting is valid for the alarm levels, rated motor power and the actual load readout in window 01.

Measurement Unit	Readout load window 01	Rated power window 41	Alarm levels windows 11,12,13,14
Kilowatt relative value (def.)*	%	kW	%
Horsepower absolute value	HP	HP	HP
Horsepower relative value*	%	HP	%
Kilowatt absolute value	kW	kW	kW

* Measured shaft power as % of rated power.

Programming

- Go to window 01.
- Press and hold  and  simultaneously for 3 seconds.
- The next unit of measurement is set and appears for 2 sec, (see examples). Repeat to select the desired measurement unit according to the table.

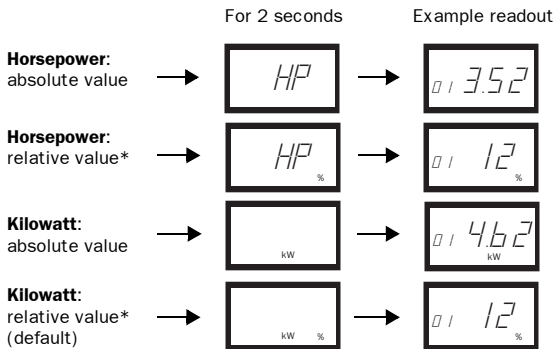



6:2 Set RATED MOTOR POWER and CURRENT (Windows 41, 42)

The RATED MOTOR POWER and the RATED MOTOR CURRENT must be set in window 41 and 42.

Example motor plate:

TYPE: T56BN/4		NR: 948287		Prot. IP: 54	
Serv: S1		Cos φ: 0.78		Is. Cl:F	
V:Y/Δ	Hz	HP	kW	RPM	A:Y/Δ
240/415	50	3	2.2	1400	5.6/9.4
260/440	60	3	2.2	1680	5.8/9.2
ASYNCHRONOUS THREE-PHASE MOTORS					

Programming

1. Go to window 41 (default = 2.2kW).
2. Press **-** or **+** to set the RATED MOTOR POWER as indicated on the motor plate (see example).
3. Press  to confirm the change.
4. Go to window 42 (default = 5.6A).
5. Press **-** or **+** to set the RATED MOTOR CURRENT as indicated on the motor plate (see example).
6. Press  to confirm the change.



6:3 Set NUMBER OF PHASES (Window 43)

The NUMBER OF PHASES must be set according to number of motor phases. Default is 3 phase.

Programming

1. Go to window 43 (default = 3PH).



2. Press  or  to set the NUMBER OF PHASES to 1 if a single-phase motor is used.
3. Press  to confirm the change.



6:4 Monitor Function (Window 05)

Monitor (Protection)	Indication in window 05	Alarm	Output Relay (default)
OVER- and UNDER-LOAD (default)	—	MAX Main-Alarm	Relay 1 (NC): 6-7
	—	MAX Pre-Alarm	Relay 2 (NO): 6-8
	—	MIN Pre-Alarm	Relay 2 (NO): 6-8
	—	MIN Main-Alarm	Relay 1 (NC): 6-7
OVERLOAD	—	MAX Main-Alarm	Relay 1 (NC): 6-7
		MAX Pre-Alarm	Relay 2 (NO): 6-8
UNDERLOAD	—	MIN Pre-Alarm	Relay 2 (NO): 6-8
		MIN Main-Alarm	Relay 1 (NC): 6-7

Over- and underload monitor

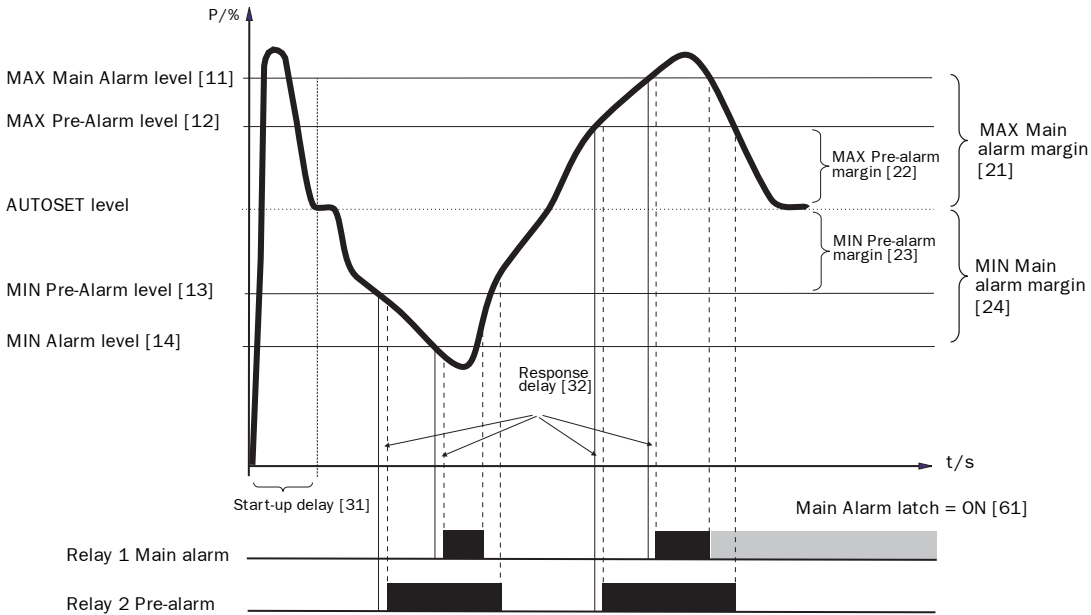



Fig 7. Over- and underload monitor.

Programming

1. Go to window 05. The default selection is OVER- and UNDERLOAD monitor.
2. Press  or  to select UNDERLOAD or OVERLOAD monitor.



OVER- and UNDERLOAD



UNDERLOAD



OVERLOAD

3. Press  to confirm the change.

6:5 Set the START DELAY (window 31)

A START DELAY must be set to allow the motor and machine to speed up and to allow the power in-rush currents to be ignored by the monitor.

Programming

1. Determine in seconds, how long it takes for the motor and machine to reach speed and for the power in-rush to pass. This will be the minimum START DELAY.
2. Go to window 31 (default = 2.0s).
3. Press **-** or **+** to set the determined START DELAY time in seconds.
4. Press **ENTER** to confirm the change.

Example: Start Delay 2.0 s

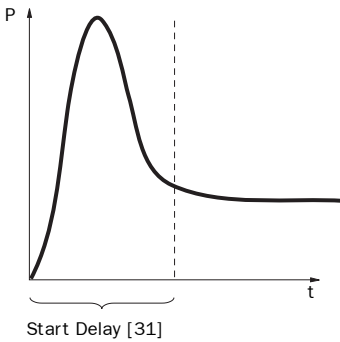



Fig 8. Start Delay.

6:6 Set Alarm levels with AUTOSET

The AUTOSET command performs a measurement of the actual motor load and automatically sets the relevant Alarm levels depending on the selected monitor function.

Protection (Monitor function window 05)	Alarm	Margin Value (Default margins)	Margins (Windows)	Alarm Level at AUTOSET
OVER- and UNDERLOAD (Default)	MAX Main-Alarm	16%	21: MAX Main Alarm margin	Normal machine load+Window 21
	MAX Pre-Alarm	8%	22: MAX Pre-Alarm margin	Normal machine load+Window 22
	MIN Pre-Alarm	8%	23: MIN Pre-Alarm margin	Normal machine load-Window 23
	MIN Main-Alarm	16%	24: MIN Main Alarm margin	Normal machine load-Window 24
OVERLOAD	MAX Main-Alarm	16%	21: MAX Main Alarm margin	Normal machine load+Window 21
	MAX Pre-Alarm	8%	22: MAX Pre-Alarm margin	Normal machine load+Window 22
UNDERLOAD	MIN Pre-Alarm	8%	23: MIN Pre-Alarm margin	Normal machine load-Window 23
	MIN Main-Alarm	16%	24: MIN Main Alarm margin	Normal machine load-Window 24

Programming

1. Start the motor and let it run at the normal machine load, until the START DELAY has expired.
2. Press  for 3 seconds. This can be done in any window.
3. The display shows “SEt”, to confirm that the AUTOSET level has been measured and the Alarm levels have been set. The display reverts to window 01.



4. If the alarm levels are too high or too low, readjust the appropriate MARGINS (see table above) and perform a new AUTOSET. Alternatively, alarm levels can be set manually – see section 7.

6:7 Set the RESPONSE DELAY (Window 32)

A RESPONSE DELAY allows the machine to remain in an over- or under-load condition for a specific time before the alarm relays are activated.

Programming

1. Determine in seconds, how long an under- or overload condition is allowed. This depends on machine properties and behavior. This will be the RESPONSE DELAY.
2. Go to window 32 (default = 0.5s).
3. Press **-** or **+** to set the determined RESPONSE DELAY time in seconds.
4. Press **ENTER** to confirm the change.

Example: RESPONSE DELAY

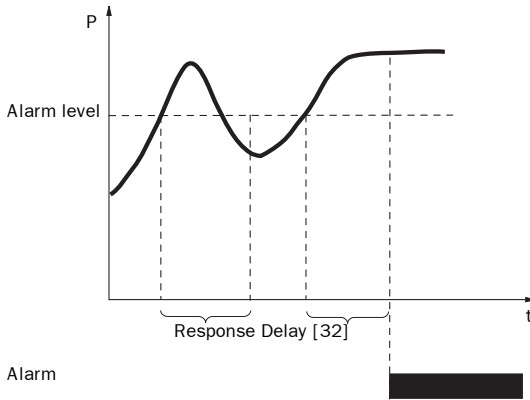

Fig 9. Response Delay.

7 ADVANCED FEATURES

Set ALARM LEVELS manually (Window 11-14)

The alarm levels can be set manually, without using the AUTOSET. Also after an AUTOSET has been performed, these levels can be readjusted e.g. for fine-tuning.

Protection (Monitor function window 05)	Alarm levels (Window)	Default
OVER- and UNDERLOAD (Default)	11: MAX Main Alarm	100%
	12: MAX Pre-Alarm	100%
	13: MIN Pre-Alarm	0%
	14: MIN Main Alarm	0%
OVERLOAD	11: MAX Main Alarm	100%
	12: MAX Pre-Alarm	100%
UNDERLOAD	13: MIN Pre-Alarm	0%
	14: MIN Main Alarm	0%

Set MARGINS (window 21-24)

The MARGINS for the AUTOSET can be changed manually. After the adjustment, the AUTOSET action must be performed once again to activate the new margins.

Protection (Monitor function window 05)	Window	Default
OVER- and UNDERLOAD (Default)	21: MAX Main Alarm margin	16%
	22: MAX Pre-Alarm margin	8%
	23: MIN Pre-Alarm margin	8%
	24: MIN Main Alarm margin	16%
OVERLOAD	21: MAX Main Alarm margin	16%
	22: MAX Pre-Alarm margin	8%
UNDERLOAD	23: MIN Pre-Alarm margin	8%
	24: MIN Main Alarm margin	16%

Set HYSTERESIS (Window 33)

The HYSTERESIS of an Alarm level prevents the alarm relay “chattering” if the load fluctuates even in a normal “stable” condition . Apply also for pre-alarm. This feature is normally only used if the “Main Alarm Latch” (Window 61) is set to “OFF”. Default = 0%.

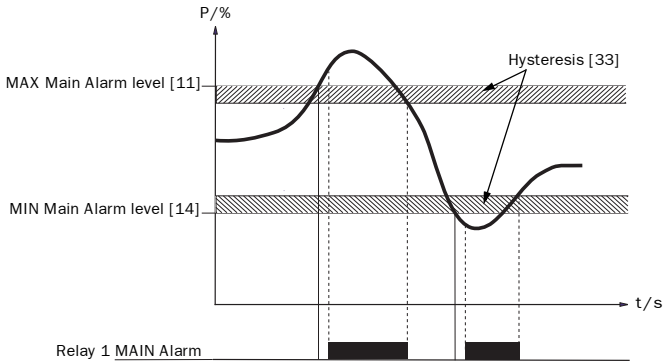

Fig. 10 Hysteresis

Set MAIN ALARM LATCH (Window 61)

The MAIN ALARM LATCH keeps the MAIN ALARM output active, even if the alarm condition has been removed (relay R1). A latched alarm output can be reset by:

- the reset key
- external reset via Digital input (see window 81).
- switching of the power of the monitor (see also “Wiring”).

Default = OFF

Set ALARM AT NO MOTOR CURRENT (Window 62)

The “ALARM AT NO MOTOR CURRENT” gives an alarm if the motor current becomes zero (ON). Default = OFF (No alarm at no motor current).

Set RELAY OUTPUTS (Window 63 and 64)

The RELAY OUTPUTs R1 and R2 can be set to NO or NC contacts.

Note!

If the power to the load monitor is switched off the relay contacts are allways in the NO.

Set DIGITAL INPUT (window 81)

The DIGITAL INPUT can be set for:

RES: External RESET (Default)	to reset an Alarm.
AU: External AUTOSET	to perform an AUTOSET with an external command.
bLo: Block Pre-Alarm	to block the Pre-Alarm function and start the Block timer. If the input is high a Pre-Alarm is blocked, e.g. it is neglected. See also window 82.

Set BLOCK TIMER (window 82)

To set the timer for the blocking time after the Block command is released (see also window 81). Default = 0.0 sec.

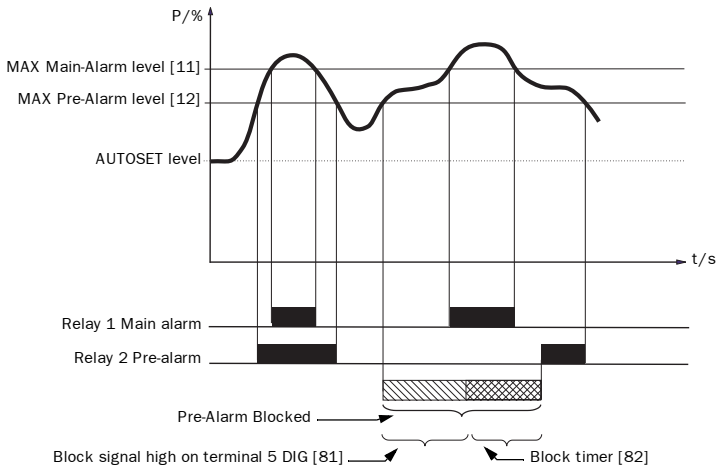

Fig 11. Block timer

Set ANALOG OUTPUT (Window 91)

The ANALOG OUTPUT provides an analog signal of either 0–20 mA or 4–20 mA signal which represents the motor shaft power. The signal can be inverted. Full scale: rated motor power. To set P-span/scaling (full scale) see below.

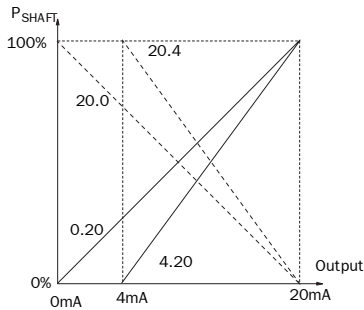

Fig. 12. Analog Output.

Set ANALOG OUTPUT LOAD RANGE: P-span (window 92-93)

With window 92 and 93 the full scale of the analog output can be set according to the minimum and maximum load (P-span).

1. In Window 91, press RESET and + for two seconds until "on" shows. Windows 92 and 93 are now active.
2. Set the lowest load value in window 92 (e.g. 20%)
3. Set the highest load value in window 93 (e.g. 55%)

The full scale of the analog output is now set between 20% and 55% load. See figure 13. To inactivate: Press RESET and + for two seconds until "OFF" shows in Window 91. Windows 92 and 93 are now inactive.

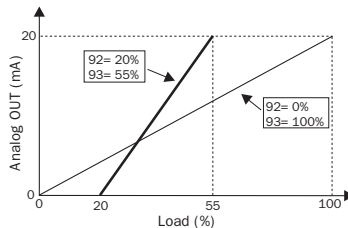

Fig. 13.

LOCK PARAMETERS (Window 04)

To avoid unintentional change of parameter settings the programming can be locked by entering the code “369” in window 04. Now only the motor variables LOAD [01], VOLTAGE [02] and CURRENT [03] can be checked. Follow the same procedure to UNLOCK the monitor. The AutoSet button is disabled when parameters are locked. AutoSet via Digital Input is always active if window 81 is set to AU (AutoSet).



Note!

The “Lock” symbol appears in all windows.

Reset to FACTORY DEFAULTS (Window 99)

The FACTORY DEFAULTS are reset by entering “dEF” in window 99. If Window 99 shows “USr” it indicates that the settings have been changed to user specific settings.

View ALARM MESSAGE (Window 00)

In an alarm condition, the window 00 appears automatically. The window indicates the following Alarm conditions. Window 00 is always blinking.

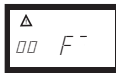

Pre-Alarm MAX level reached



Under voltage, switch off the supply!



Alarm MAX level reached



Over voltage, switch of the supply!



Pre-Alarm MIN level reached



No motor current
Window 62=on

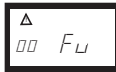

Alarm MIN level reached



Out Of Range. This message appears only in window 01 (actual load) or 03 (actual current)

8 TROUBLESHOOTING

Problem	Solution
Window 01 always shows zero load, even if the motor is running	<ul style="list-style-type: none"> - Check the connection of the current transformer(s). - Check that value of the rated motor power in window 41 is the same as the rated motor power on the motor plate. - Check that window 03 shows a phase current value in correspondents with the rated motor current.
Window 01 shows an improper power value when the motor is running	<ul style="list-style-type: none"> - Check that the current transformer is connected in phase L1.
Window 03 shows an improper value of the phase current	<ul style="list-style-type: none"> - Check that current transformer has been selected according to the tables 1 and 2. - Check that the number of windings is according to table 1 and 2. - Check that the value of the motor current in window 42 is the same as the value of the motor current on the motor plate.
The monitor never gives an alarm	<ul style="list-style-type: none"> - Check that window 01 shows a value greater than zero. - Check the alarm levels in windows 11 to 14. If not correct readjust the levels or perform an AUTASET.
The monitor always gives an alarm	<ul style="list-style-type: none"> - Check the alarm levels in windows 11 to 14. If not correct readjust the levels or perform an AUTASET. - Check if the monitor is programmed for "latched alarm" (window 61=on). If so reset the monitor by pressing the reset key.
Window 00 shows "LU" or "OU". Under- or over voltage alarm.	<p>Switch off the supply:</p> <ul style="list-style-type: none"> - Check that the supply voltage is corresponding with the voltage range on the monitor type plate.
Window 01 shows "oor". "Out Of Range" alarm.	<ul style="list-style-type: none"> - The measured shaft power is higher than 125% of the rated motor power programmed in window 41.
Window 03 shows "oor". "Out Of Range" alarm.	<ul style="list-style-type: none"> - The measured motor current is higher than 125% of the rated motor current programmed in window 42.
The alarm relays are not switching	<ul style="list-style-type: none"> - Check that the wire links between terminals 6 and 7 are removed according to "Wiring".

9 TECHNICAL DATA

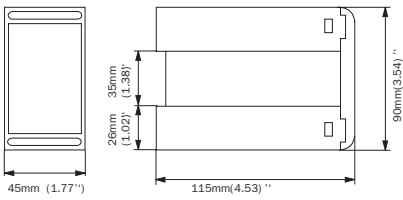
Dimensions (WxHxD)	45x90x115 mm (1.77" x 3.54" x 4.53") 
Mounting	35 mm DIN-rail 46277
Weight	0.30 kg (10.5 oz)
Supply voltage ($\pm 10\%$)	1x100-240 VAC, 3x100-240 VAC, 3x380-500 VAC, 3x525-600 VAC, 3x600-690 VAC
Frequency	50 or 60 Hz
Current input	Current transformer; CTM 010, 025, 050 and 100 (>100A extra transformer needed)
Power consumption	max 6 VA
Start-up delay	1-999 s
Hysteresis	0-50% of rated motor power
Response delay	0.1-90 s
Relay output	5 A/240 VAC Resistive, 1.5 A/240 VAC Pilot duty/AC12
Analog output	max load 500 ohm
Digital input	max 240 VAC or 48 VDC. High: ≥ 24 VAC/DC, Low: < 1 VAC/DC. Reset > 50 ms
Fuse	max 10 A
Terminal wire size	Use 75°C copper (CU) wire only. 0.2-4.0 mm ² single core (AWG12). 0.2-2.5 mm ² flexible core (AWG14), stripped length 8 mm (0.32")
Terminal tightening torque	0.56-0.79 Nm (5-7 lb-in)
Accuracy	$\pm 2\%$, ± 1 unit $\cos \phi > 0.5$; excl. current transformer; $+20^\circ\text{C}$ ($+68^\circ\text{F}$)
Repeatability	± 1 unit 24h; $+20^\circ\text{C}$ ($+68^\circ\text{F}$)
Temperature tolerance	max 0.1%/°C
Operating temperature	-20 to $+50^\circ\text{C}$ (4°F to $+122^\circ\text{F}$)
Storage temperate	-30 to $+80^\circ\text{C}$ (22°F to $+176^\circ\text{F}$)
Protection class	IP20
Approved to	CE, cUL and UL and CSA standard (up to 600 V)

Dismantling and disposal

The housing is made of recyclable plastic, PC/ABS and the circuit board contain small amount of tin and lead. When disposing, the parts must be handled and recycled in accordance with local regulations.

EU (European Union) specifications

EMC **EN 50081-1, EN 50081-2,**
EN 50082-1, EN 61000-6-2

Electrical safety IEC 947-5-1

Rated insulated voltage 690 V

Rated impulse withstand voltage 4000V

Pollution degree 2

Terminals 3, 4, 5, 6, 7 and 8 are basic insulated from the line.

Terminals 3 and 4 are basic insulated from terminals 5, 6, 7 and 8.

US specifications

FCC (Federal Communications Commission). This equipment has been tested and found to comply with the limits for a class A digital device pursuant to the Part 15 of the FCC Rules. These limits are designed to provide reasonable protection against harmful interference when the equipment is operated in a commercial environment. This equipment generates, uses and can radiate radio frequency energy and, if not installed and used in accordance with the instruction manual, may cause harmful interference, in which case, the user will be required to correct the interference at their own expense.

Canada specifications

DOC (Department of communications). This digital apparatus does not exceed the Class A limits for radio noise emissions from digital apparatus as set out in the Canadian interference-Causing Equipment Regulations. Le présent appareil numérique n'émet pas de bruits radio-électriques dépassant les limites applicables aux appareils numériques de la Classe A prestite dans le Régelement sur le brouillage radioélectrique édicté du Canada.

10 PARAMETER LIST

Window	Function	Range	Default	Custom	Symbol
00	Alarm indication				
01	Measured shaft power in % rated power	0-125	0-125		%
	Measured shaft power in kW	0-745			kW
	Measured shaft power in % rated power	0-125			%
	Measured shaft power in HP	0-999			
02	Measured line voltage	90-760 V			V
03	Measured current	0.00-999 A			A
04	Parameter lock	0-999			🔒
05	Monitor function	OVER- and UNDER-LOAD, OVERLOAD, UNDERLOAD	OVERLOAD and UNDERLOAD		
11	MAX Main Alarm (relay R1)	0-125	100		%
		0-745	2.2		kW
		0-125	100		%
		0-999	3		
12	MAX Pre-Alarm (relay R2)	0-125	100		%
		0-745	2.2		kW
		0-125	100		%
		0-999	3		
13	MIN Pre-Alarm (relay R2)	0-125	0		%
		0-745	0		kW
		0-125	0		%
		0-999	0		

Window	Function	Range	Default	Custom	Symbol
14	MIN Main Alarm (relay R1)	0-125	0		%
		0-745	0		kW
		0-125	0		%
		0-999	0		
21	MAX Main Alarm margin	0-100	16		%
22	MAX Pre-Alarm margin	0-100	8		%
23	MIN Pre-Alarm margin	0-100	8		%
24	MIN Main Alarm margin	0-100	16		%
31	Start delay	1-999	2		s
32	Response delay	0.1-90	0.5		s
33	Hysteresis	0-50	0		%
41	Rated motor power	0.10-745	2.2		kW
		0.13-999	3		
42	Rated current	0.01-999	5.6		A
43	Number of phases	1PH/3PH	3PH		
61	Main alarm latch	on/OFF	OFF		
62	Alarm at no motor current	on/OFF	OFF		
63	Main Alarm relay R1	nc/no	nc		
64	Pre-Alarm relay R2	nc/no	no		
81	Digital input	rES/AU/bLo	rES		
82	Block timer	0.0-90	0.0		s
91	Analog output	0.20/4.20/20.0/ 20.4	0.20		
92*	Analog Out low value	0-100	Not used		
93*	Analog Out high value	0-125	Not used		
99	Factory defaults	dEF/USr	dEF		

* Optional parameters, see section 7.

11 SERVICE

This manual is valid for the following model:

EL-FI M20

Document number: 01-2551-01

Document version: r2

Date of release: 2003-04-15

Emotron AB reserves the right to alter product specifications without prior notification. No part of this document may be reproduced without permission from Emotron AB.

For more information contact your local sales outlet or one of the Emotron companies below or visit us at: **www.emotron.com**

Emotron AB, Headquater, **Sweden**

Mörsaregatan 12, Box 222 25

SE-250 24 Helsingborg, Sweden

Tel. +46 42 169900

Fax +46 42 169949

Emotron Antriebssysteme GmbH, **Germany**

Tel. +49 3943 92050

Fax +49 3943 92055

Emotron B.V., The **Netherlands & Belgium**

Tel. +31 497 389222

Fax +31 497 386275

Emotron El-Fi SA, **Spain**

Tel. +34 93 209 14 99

Fax +34 93 209 12 45

Emotron Inc., **USA**

Tel. +1 (419) 841-7774

Fax +1 (419) 843-5816

K.K: El-Fi, **Japan**

Tel. +81 42 528 88 20

Fax +81 42 528 88 21

Protected by utility patent SE 9703952-3

International utility patent application pending WO 9925049