

# GP SERIES CURVEBOOK

Effective 12-1-03  
Literature ID Number FT03-890, Rev. 0

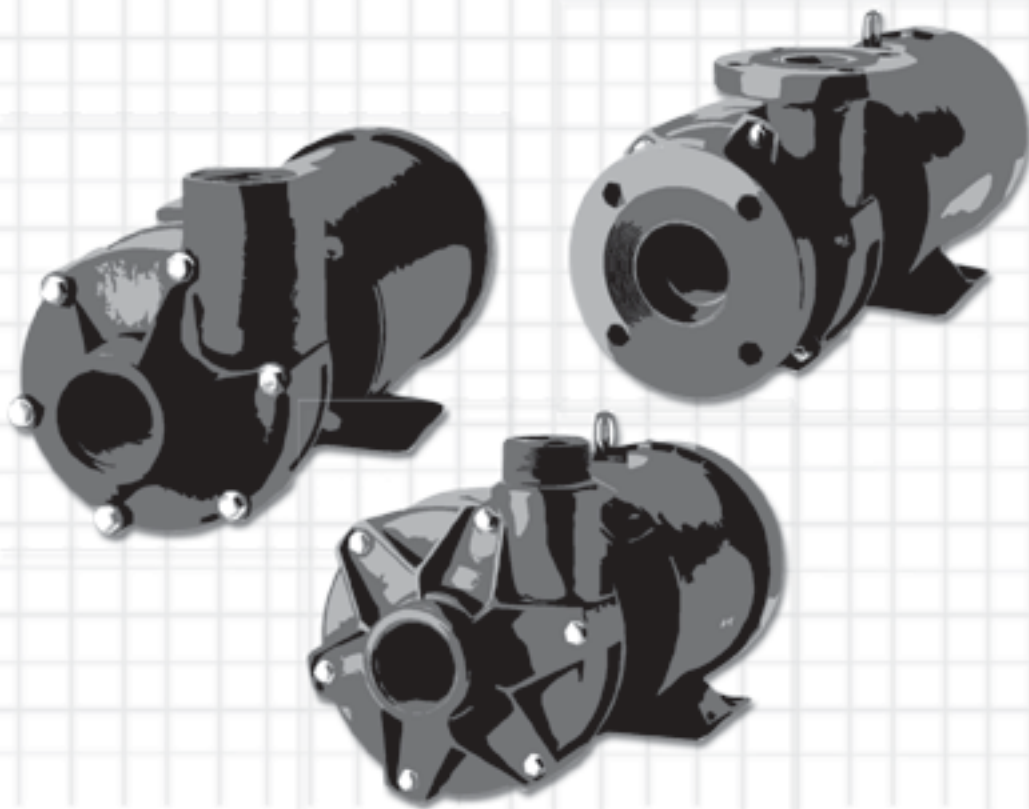

# TABLE OF CONTENTS

GP11, 3450 rpm, 60 Hz .....	4
GP11, 1725 rpm, 60 Hz .....	5
GP11, 2900 rpm, 50 Hz .....	6
GP11, 1450 rpm, 50 Hz .....	7
GP22/32, 3450 rpm, 60 Hz .....	8
GP22/32, 1725 rpm, 60 Hz .....	9
GP22/32, 2900 rpm, 50 Hz .....	10
GP22/32, 1450 rpm, 50 Hz .....	11

**MODEL GP11**

3450 rpm, 60 Hz  
Suction: 1 1/2" FNPT  
Discharge: 1 1/2" FNPT

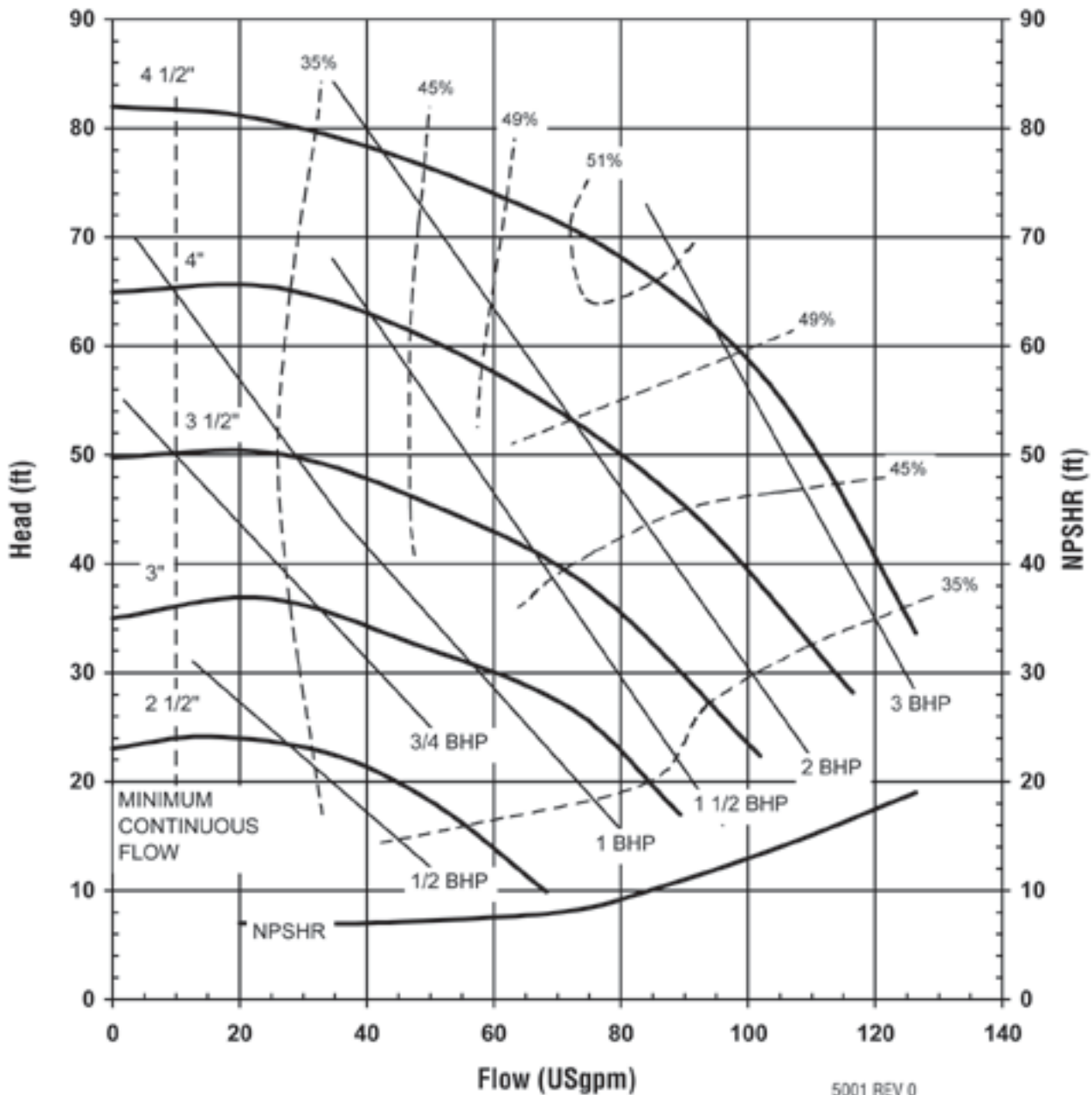

5001 REV 0  
08/06/03

**MODEL GP11**

1725 rpm, 60 Hz  
Suction: 1 1/2" FNPT  
Discharge: 1 1/2" FNPT

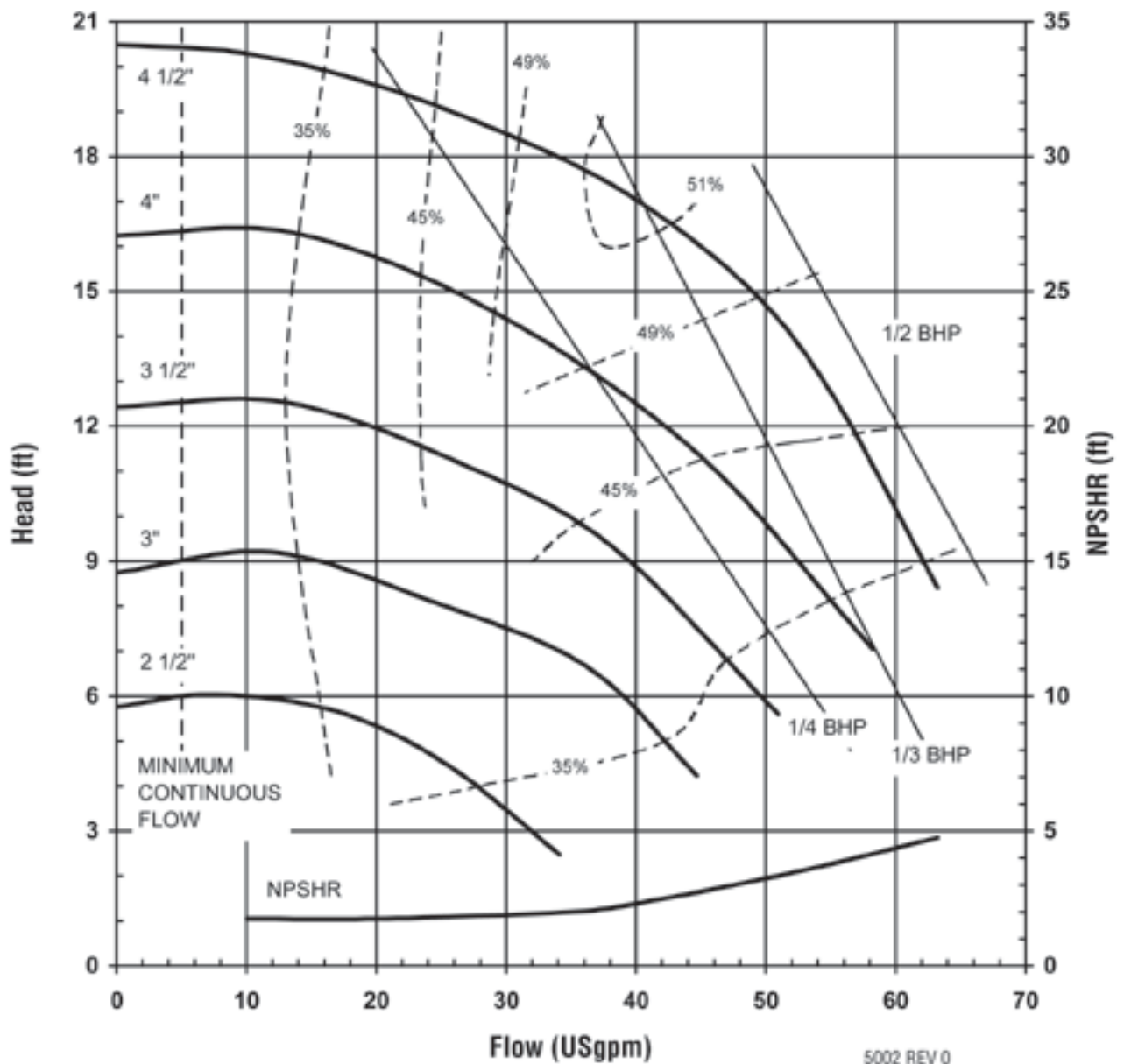

5002 REV 0  
08/06/03

**MODEL GP11**

2900 rpm, 50 Hz

Suction: 1 1/2" FNPT

Discharge: 1 1/2" FNPT

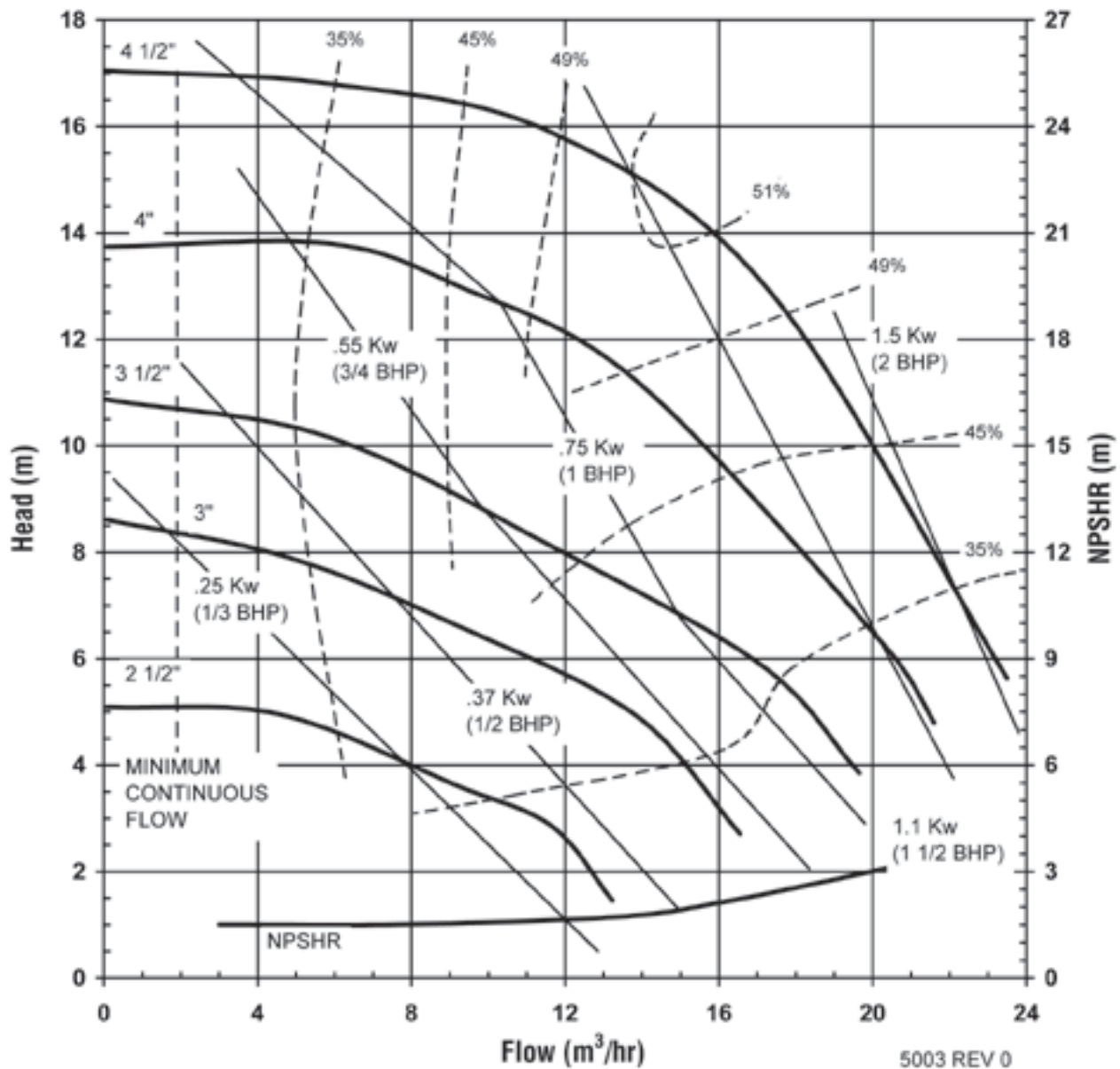

5003 REV 0  
08/06/03

**MODEL GP11**

1450 rpm, 50 Hz  
Suction: 1 1/2" FNPT  
Discharge: 1 1/2" FNPT

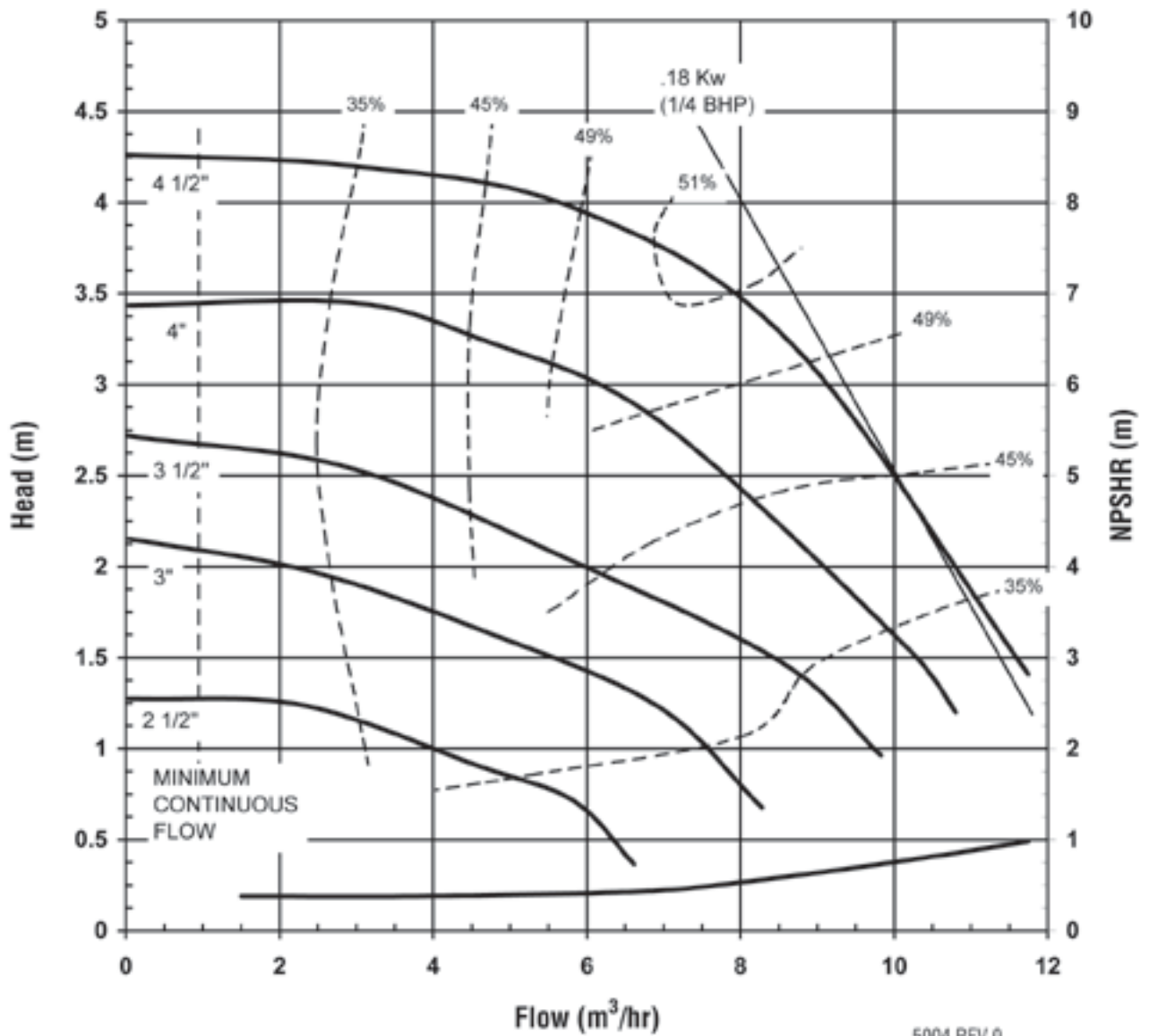

5004 REV 0  
08/06/03

**MODEL GP22/32**

3450 rpm, 60 Hz

Suction: 2" FNPT/3" FLANGE

Discharge: 2" MNPT/2" FLANGE

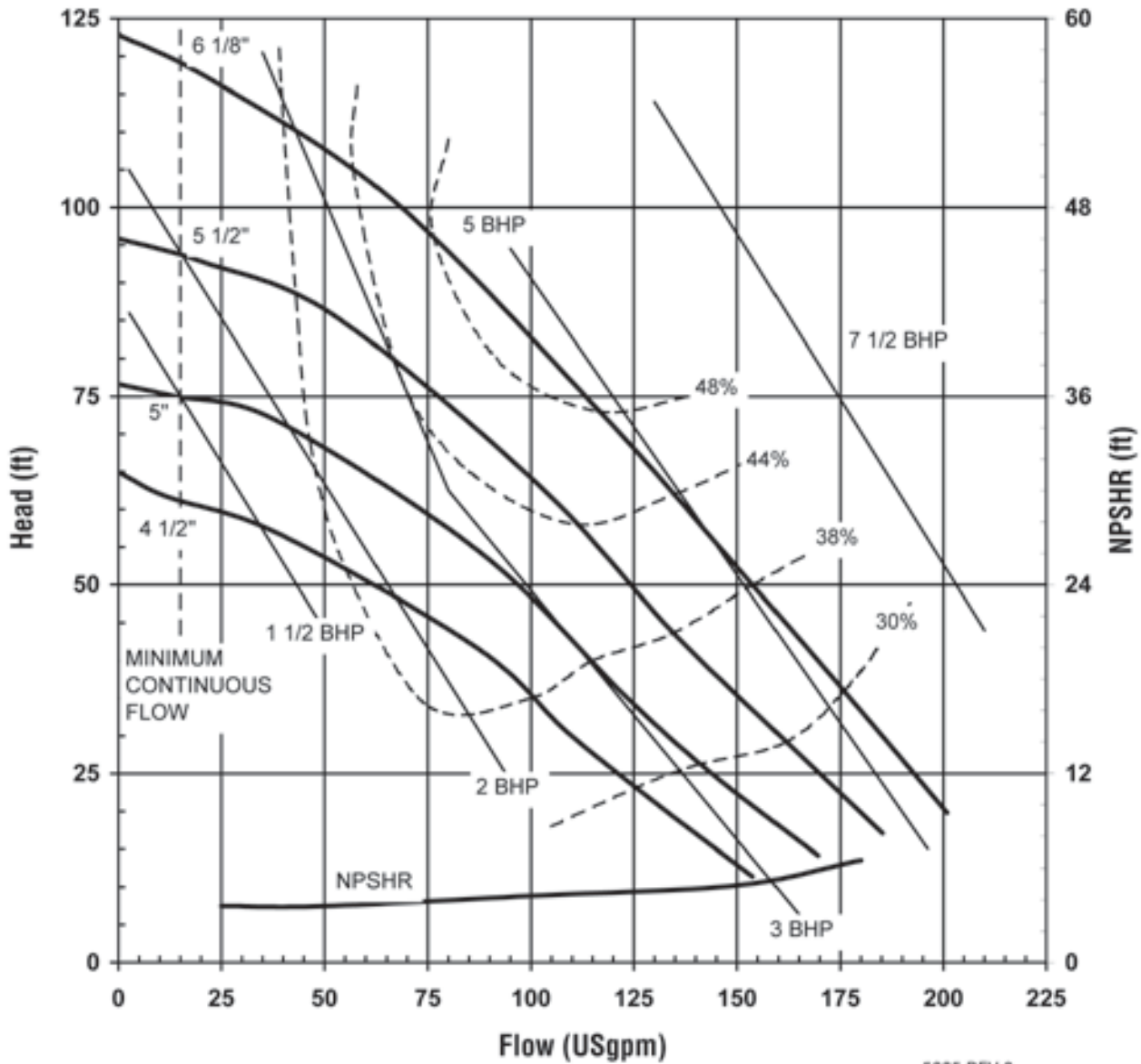

5005 REV 0  
08/28/03



**GP SERIES  
STANDARD  
PERFORMANCE CURVE**

**MODEL GP22/32**

1725 rpm, 60 Hz

Suction: 2" FNPT/3" FLANGE

Discharge: 2" MNPT/2" FLANGE

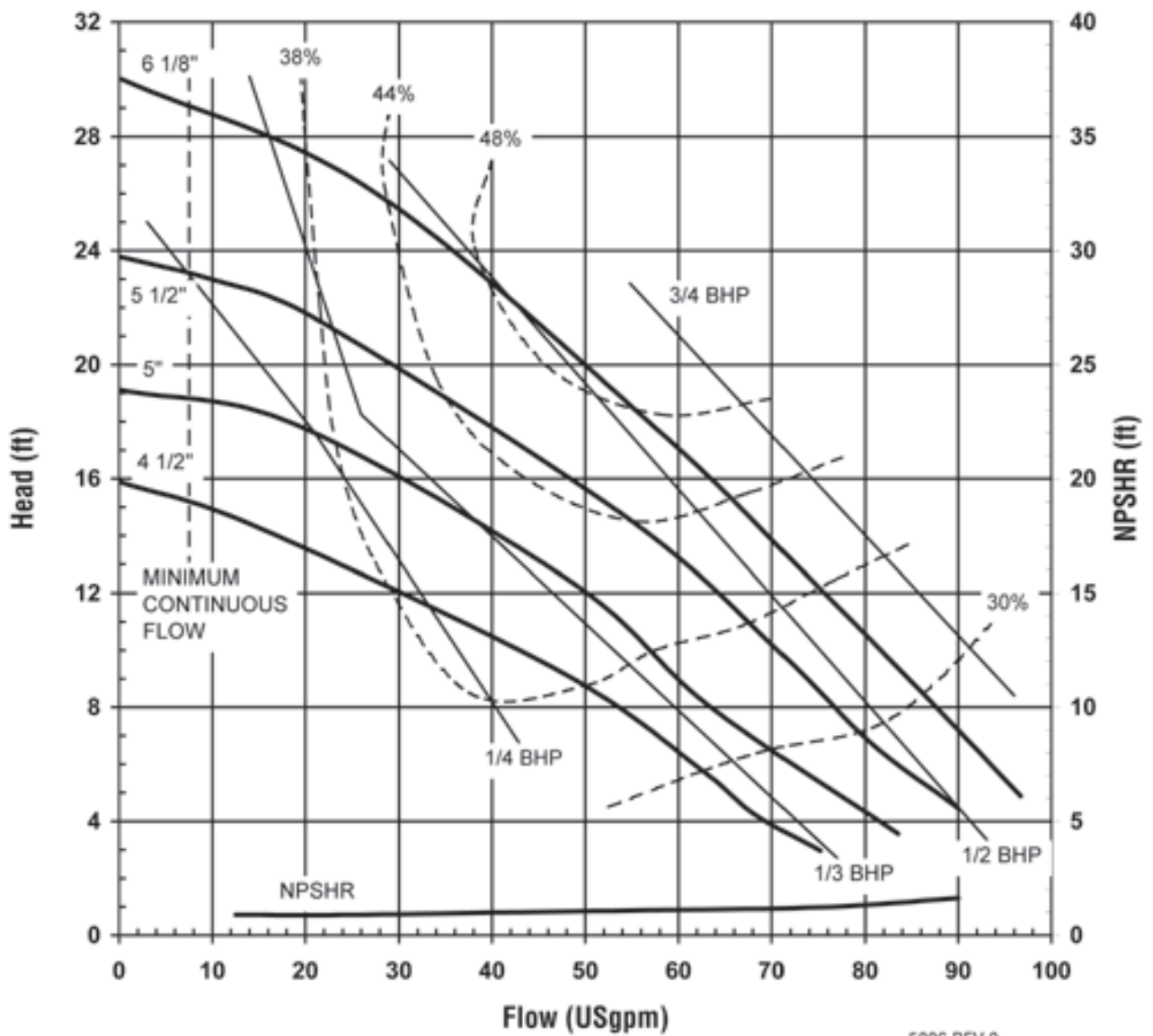

5006 REV 0  
08/28/03

**MODEL GP22/32**

2900 rpm, 50 Hz

Suction: 2" FNPT/3" FLANGE

Discharge: 2" MNPT/2" FLANGE

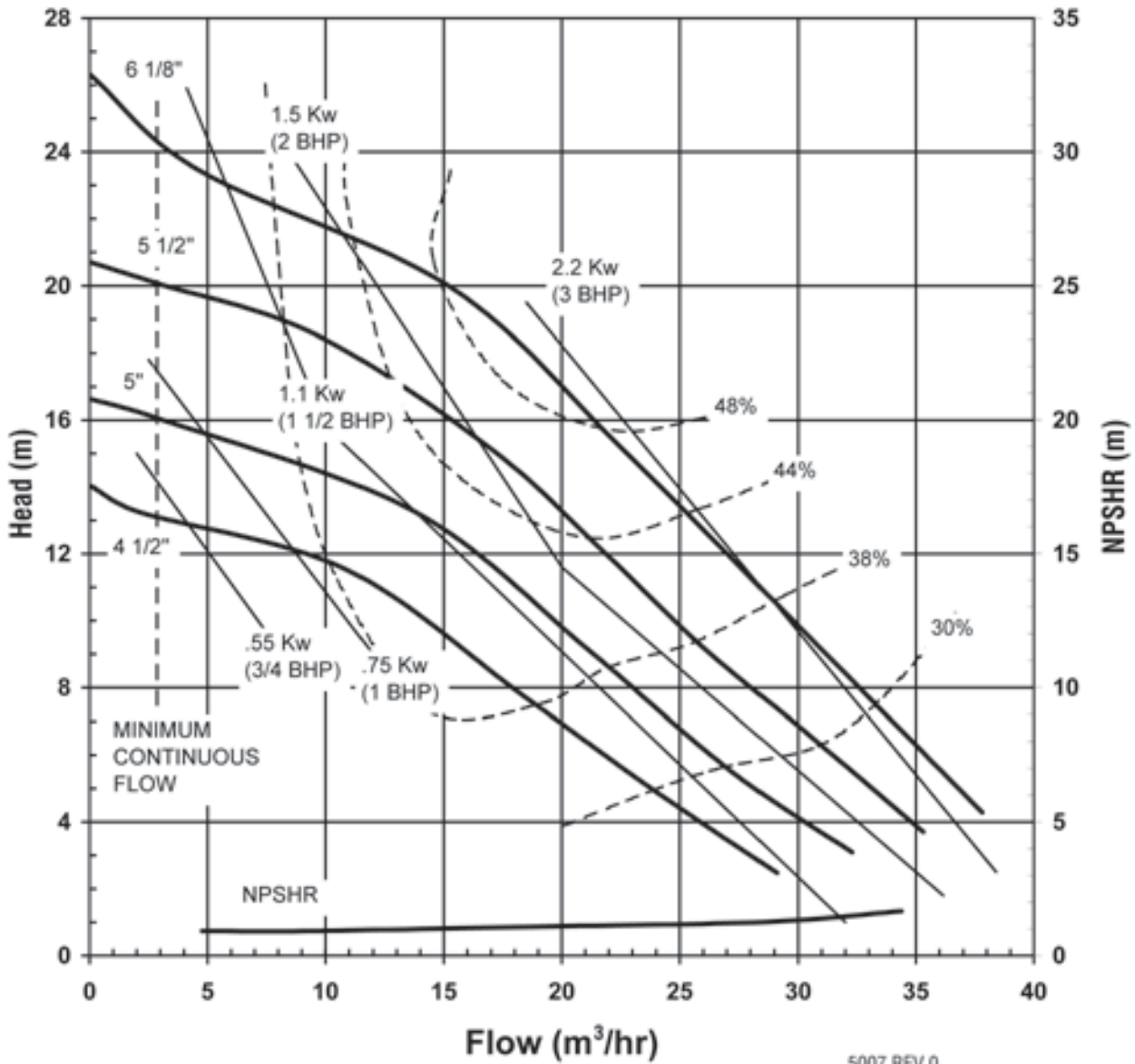

5007 REV 0  
08/28/03

**MODEL GP22/32**

1450 rpm, 50 Hz  
Suction: 2" FNPT/3" FLANGE  
Discharge: 2" MNPT/2" FLANGE

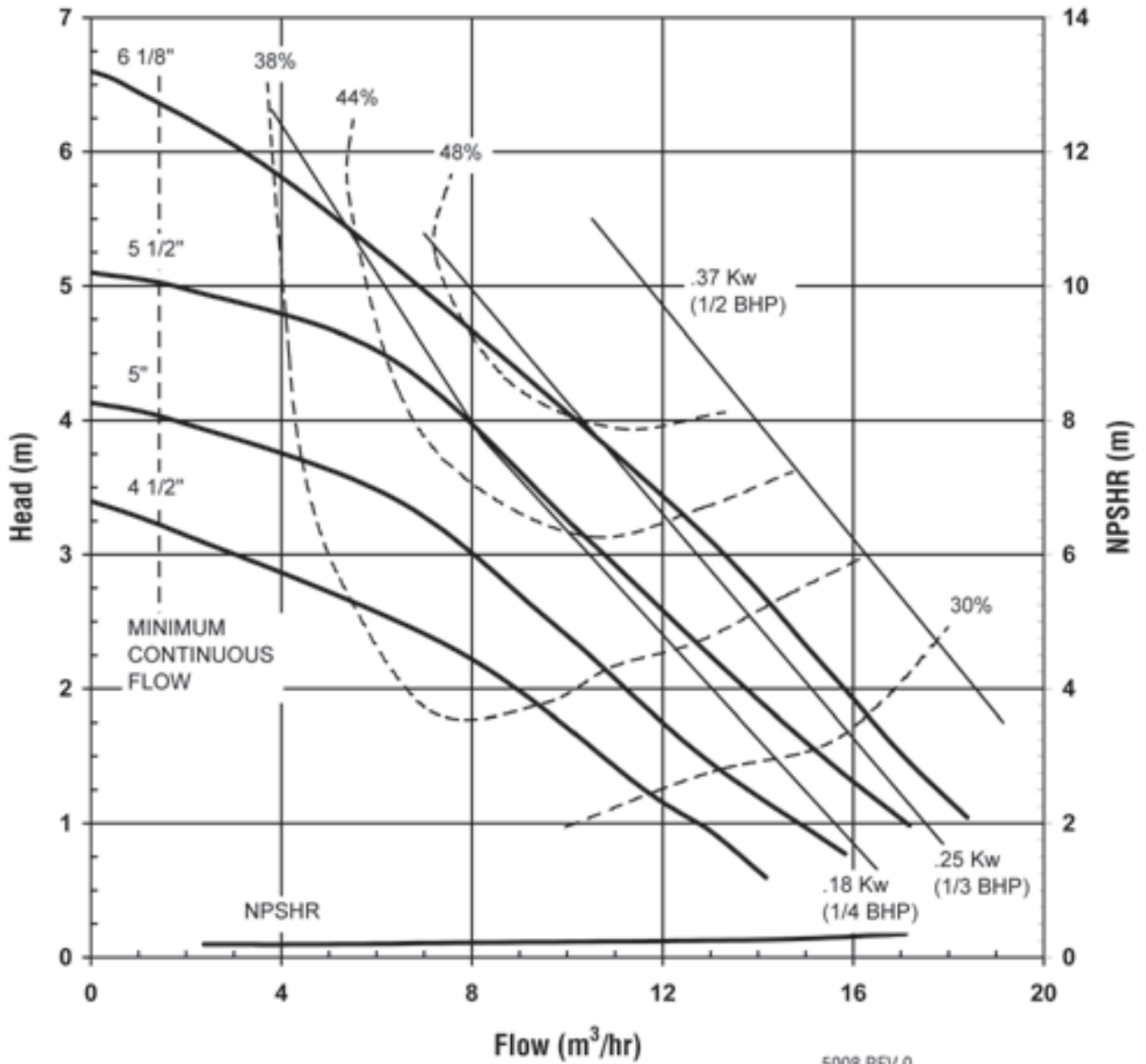

5008 REV 0  
08/28/03