

Signet 2750 DryLoc® pH/ORP Sensor Electronics

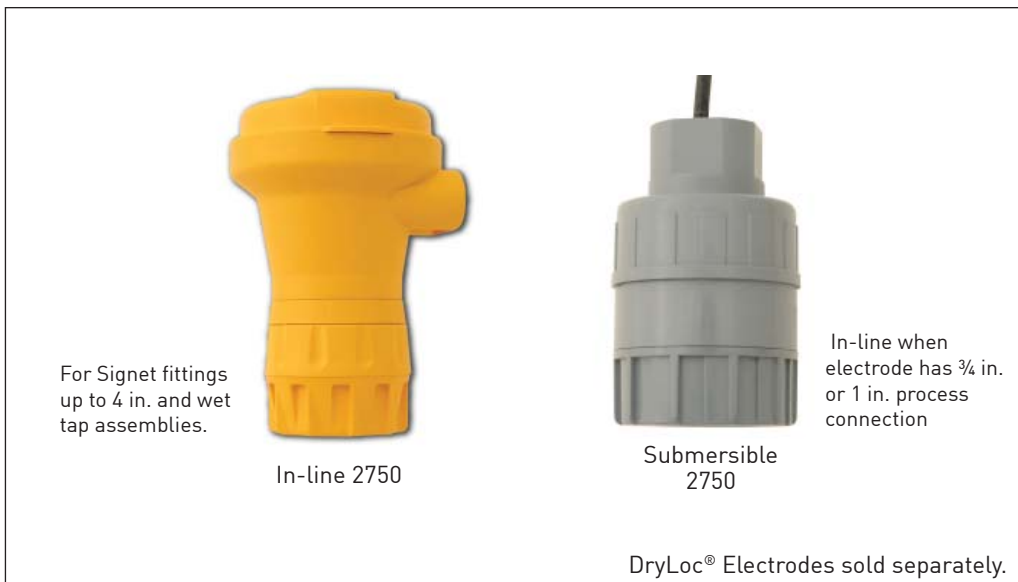

Features

- In-line integral mount and submersible installation versions
- Automatic temperature compensation
- Auto configuration for pH or ORP operation
- Optional EasyCal calibration aid with automatic buffer recognition
- Junction boxes for convenient wiring

Description

The Signet 2750 pH/ORP Sensor Electronics featuring the DryLoc® connector, provides a variety of functions to suit various requirements.

The 2750 has a preamplified signal and features two different outputs: a two-wire 4 to 20 mA loop output with EasyCal function or a digital (S³L) output which allows for longer cable lengths and is compatible with the Signet 8900 Multi-Parameter Controller.

The 2750 self-configures for pH or ORP operation via automatic recognition of the electrode type. The optional EasyCal feature allows simple push-button calibration and includes an LED indicator for visual feedback.

The DryLoc® electrode connector quickly forms a robust assembly for submersible and in-line installations. NEMA 4X junction enclosures are integral parts of the 2750 in-line version and are also available as accessories for the submersible 2750.

The 2750 submersible preamplifier can also be used as an In-line preamplifier when used with the 3/4" or 1" threaded sensors including the 2724, 2774 and 2764 series electrodes. The 2750 In-line preamplifier can be used with Signet fittings up to DN100 (4 in.) and wet-tap assemblies.

Applications

- Water/Wastewater Treatment
- Neutralization Systems
- Scrubber Control
- Effluent Monitoring
- Surface Finishing
- Flocculent Coagulation
- Heavy Metal Removal and Recovery
- Toxics Destruction
- Sanitization Systems
- Pool & Spa Control
- Aquatic Animal Life Support Systems

System Overview

In-Line Installation		Submersible Installation	Wet-Tap Installation
Panel Mount Signet 8900 Multi-Parameter Controller (sold separately) 	4 to 20 mA Input Chart Recorder OR Programmable Logic Controller 	Panel Mount Signet 8900 Multi-Parameter Controller (sold separately) 	4 to 20 mA Input Chart Recorder OR Programmable Logic Controller
Signet 2750 Sensor Electronics 	Signet Universal junction box (3-8050-2) EasyCal (sold separately) Signet 2750 Sensor Electronics 	Pipe extension or conduit with 3/4 in. NPT or ISO 7/1-R 3/4 threads (customer supplied) 	Signet 2750 Sensor Electronics with Signet Wet-Tap Electrode 2756, 2757 (each sold separately)
DryLoc® pH/ORP Electrodes 2724-2726, 2764-2767, 2774-2777 (sold separately) 		Signet 2750 Sensor Electronics 	Signet 3719 Wet-Tap (sold separately)
2724-2726 DryLoc® Electrodes: Use GF Fittings* or 3/4 in. NPT fittings (customer supplied) 2764-2767 and 2774-2777 DryLoc® Electrodes: Use 3/4 in. or 1 in. NPT fittings (customer supplied)		DryLoc® pH/ORP Electrodes 2724-2726, 2764-2767, 2774-2777 (sold separately) 	GF PP Clamp-On Saddles for 3719 Wet-Tap or GF Tees and Fittings (sold separately) see model 3719 for more info



*See Fittings section for more information.

Dimensions

3-2750-1,-2

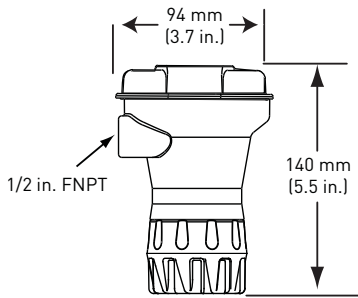

3-2750-3, -4

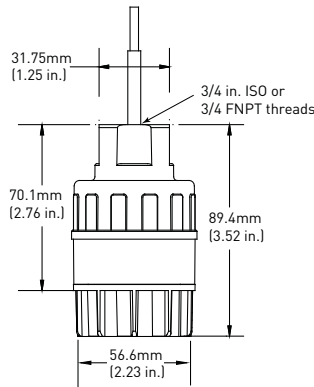

Specifications

General

Compatible Electrodes:

Signet DryLoc® pH and ORP Electrodes
Models 2724-2726, 2756-2757 Wet-Tap,
2764-2767, 2774-2777,

Operating Range:

- pH: 0 to 14 pH
- ORP: $\pm 2,000$ mV

Response Time:

- pH: < 6 sec. for 95% of change
- ORP: application dependent

Materials:

- In-line: Valox® (PBT)
- submersible: CPVC

Electrical

Cable:

4.6 m/15 ft, 3-conductor shielded
22 AWG, 100 ft max.

Power:

- 12 to 24 VDC $\pm 10\%$, regulated for 4 to 20 mA output
- 5 to 6.5 VDC $\pm 5\%$ regulated recommended, 3 mA max., for digital (S³L) output

Current output:

- pH: Fixed 4 to 20 mA, isolated, = 0 to 14 pH (custom scaling available)
- ORP: Fixed 4 to 20 mA, isolated, = -1000 to 2000 mV (custom scaling available from ± 2000 mV)
- Max Loop Resistance: 100 Ω max. @ 12 V
325 Ω max. @ 18 V
600 Ω max. @ 24 V
- Accuracy: ± 32 μ A
- Resolution: ± 5 μ A
- Update Rate: 0.5 seconds
- Error indication: 3.6 mA

Digital (S³L) output:

- Serial ASCII, TTL level 9600 bps
- Accuracy: pH: ± 0.03 pH @ 25 °C (77 °F)
ORP: ± 2 mV @ 25 °C (77 °F)
- Resolution: pH: ≤ 0.01 pH
ORP: 1 mV
Temp.: ≤ 0.2 °C (32.3 °F)

Electrical (continued)

- Update Rate: 0.5 seconds
- Available Data: Raw mV, pH or ORP, temperature (pH)
- Error indication: Open input diagnostic
- Input Impedance, Z: $>10^{11}\Omega$

Environmental

Enclosure:

- 3-2750-1 & -2: NEMA 4X/IP65 with electrode connected
- 3-2750-3 & -4: NEMA 6P/IP68 with electrode and watertight conduit and/or extension pipe connected

Max. Temperature/Pressure Rating

Operating Temperature:

- Temperature (submersible): 0 °C to 85 °C (32 °F to 185 °F)
- Temperature (in-line): 0 °C to 110 °C (32 °F to 230 °F)

Storage Temperature:

-20 °C to 85 °C (-4 °F to 185 °F)

Relative Humidity:

0 to 95%, non-condensing (without electrode connected)







Shipping Weight

- 2750-1 & 2: 0.75 kg 1.65 lb
- 2750-3 & -4: 0.64 kg 1.41 lb

Standards and Approvals

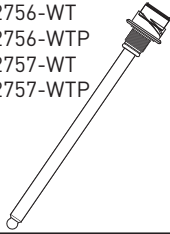
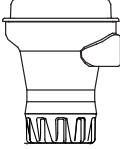
- CE
- Manufactured under ISO 9001 for Quality and ISO 14001 for Environmental Management

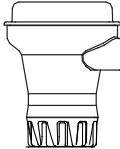
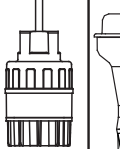
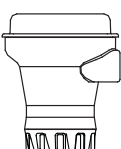
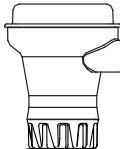
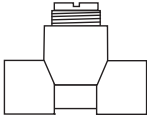
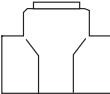
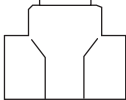
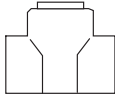
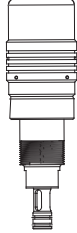
2750 Product Selection Guide

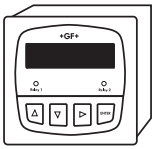
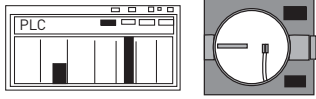
<p>1. Choose the Electrode</p>	<p>2724-2726 3-2724-00, -01 3-2725-60, -61 3-2726-00, -01 3-2726-HF-00, -01 3-2726-LC-00, -01</p> 	<p>2764-2767 Differential</p> <p>3-2764-2 3-2765-1 3-2766-2 3-2767-1</p> 	<p>2774-2777</p> <p>3-2774-1 3-2775-1 3-2776-1 3-2777-1</p> 	<p>2756 and 2757 Wet-Tap</p> <p>3-2756-WT 3-2756-WTP 3-2757-WT 3-2757-WTP</p> 		
<p>2. Determine the mounting style:</p> <p>In-line</p> <p>-In-line fitting</p> <p>Submersible</p>	 <p>2750-1 or -2</p>	 <p>2750-3 or -4</p>	 <p>2750-1 or -2</p>	 <p>2750-3 or -4</p>	 <p>2750-1 or -2</p>	 <p>2750-1 or -2</p>
 <p>Signet fitting</p>	 <p>3/4" reducing tee</p>	 <p>1" threaded tee</p>	 <p>3/4" reducing tee</p>	 <p>3719 Wet-Tap Assembly</p> <p>(Submersible not applicable with Wet-Tap assembly)</p>		
<p>2750-3 or -4 and cable conduit (customer supplied) connected to 3/4" sensor electronics</p> 	<p>3719 Wet-Tap Assembly</p> <p>(Submersible not applicable with Wet-Tap assembly)</p>					
<p>3. Junction Boxes</p>	<p>3-8050-1: Use when extending the submersible cable over long distance. 3-8050-2: Use with the submersible 2750-3 or -4 and the in-line 2750-1 for best calibration results with the EasyCal function when using the blind 4 to 20 mA output.</p>					
<p>4. Choose the output instrument</p> <p>Digital (S³L) 4 to 20 mA</p>	 <p>8900 Multi-Parameter Controller</p>	<p>OR</p>  <p>PLCs or Chart Recorders</p>				

Ordering Information

Model 2750

Ordering Information

- 1) Model 2750 requires 12 to 24 VDC to function as a blind 4 to 20 mA output transmitter.
- 2) Order a 3-2750-2 or any other 2750 with a junction box 3-8050-2 if the EasyCal feature is desired.
- 3) Conduit and mounting brackets for submersion installation must always be used (customer supplied).
- 4) The 3-2759 System Tester must be ordered with the adapter cable 3-2759.391 for exclusive use with the 2750.
- 5) All sensor electronics, preamplifiers and connectors require a DryLoc® electrode for full system installation.

Sensor Electronics		
3-2750		Sensor Electronics with preamplified signal and Digital (S ³ L) output (for use with the 8900 controller) or 4 to 20 mA output - power supplied to unit dictates output type.
↓	-1	In-line Sensor electronics (yellow body) - recommended for 8900 Controller
	-2	In-line Sensor electronics with EasyCal (yellow body) - recommended for 4 to 20 mA use
	-3	Submersible Sensor electronics with 4.6 m (15 ft) cable and ¾ in. NPT threads - when 4 to 20 mA is required use the 3-8050-2 junction box with EasyCal
	-4	Submersible Sensor electronics with 4.6 m (15 ft) cable and ISO 7/1R 3/4 threads - when 4 to 20 mA is required use the 3-8050-2 junction box with EasyCal
	↓	
3-2750	-2	Example Part Number

Mfr. Part No.	Code
3-2750-1	159 000 744
3-2750-2	159 000 745
3-2750-3	159 000 746
3-2750-4	159 000 842

Accessories and Replacement Parts

Mfr. Part No.	Code	Description
Calibration		
3-2700.395	159 001 605	Calibration kit: includes 3 PP cups, cup stand, 1 pint pH 4.01, 1 pint pH 7.00
3822-7115	159 001 606	20 gm bottle Quinhydrone for ORP calibration (must use pH 4.01 and/or pH 7.00 buffer solutions)
3-2759	159 000 762	pH/ORP system tester (adapter cable sold separately)
3-2759.391	159 000 764	2759 adapter cable for use with 2750
3-0700.390	198 864 403	DryLoc® sensor electronics
3822-7004	159 001 581	pH buffer kit (1 each 4, 7, 10 pH buffer in powder form, makes 50 ml of each)
3822-7007	159 001 582	pH 4 buffer solution, 1 pint (473 ml) bottle
3822-7010	159 001 583	pH 7 buffer solution, 1 pint (473 ml) bottle
		pH 10 buffer solution, 1 pint (473 ml) bottle
Mounting		
3-8050-1	159 000 753	Universal mount junction box
3-8050-2	159 000 754	Universal mount junction box w/EasyCal (for submersible applications, use with 3-2750-3/4 where 4 to 20 mA is required)
3-9000.392-1	159 000 839	Liquid tight connector kit, NPT (1 connector)
3-9000.392-2	159 000 841	Liquid tight connector kit, PG 13.5 (1 connector)
Other		
5523-0322	159 000 761	Sensor cable (per ft), 3-cond. plus shield, 22 AWG, black/red/white (for use with 2750)

Application Tips

- The EasyCal feature automatically recognizes standard 4.0, 7.0, and 10.0 pH buffer or ORP Quinhydrone solutions of 87 and 264 mV and simplifies calibration
- Frequency of calibration of electrodes is dependent upon the application.

3-2750.099 Rev B (01/10)

© Georg Fischer Signet LLC

3401 Aerojet Avenue, El Monte, CA 91731-2882 U.S.A. • Tel. (626) 571-2770 • Fax (626) 573-2057 • www.gfsignet.com • e-mail: signet.ps@georgfischer.com

Specifications subject to change without notice. All rights reserved. All corporate names and trademarks stated herein are the property of their respective companies.